

CONSTRUCTION DETAIL NO. 5

NOTES

- 1) DIMENSIONS OF CONCRETE COLLARS BASED ON 2000 P.S.F. SOIL BEARING.
- 2) SPECIFICATIONS OF MEGA-LUGS SHALL CONFORM TO THE PIPE MANUFACTURERS SUPPLIED SHOP DRAWINGS, WHICH SHALL INDICATE A THRUST RATING NOT LESS THAN THAT INCLUDED IN THE CHART BELOW.
THRUST COLLARS SHALL CONFORM TO THE PIPE MANUFACTURER'S SUPPLIED SHOP DRAWINGS WHICH SHALL INDICATE A THRUST RATING NOT LESS THAN THAT INCLUDED IN THE CHART BELOW.
- 3) DIMENSIONS OF WELDED STEEL OR DUCTILE IRON
- 4) CONCRETE SHALL HAVE A COMPRESSIVE STRENGTH OF 3,000 P.S.I. AT 28 DAYS. "HIGH EARLY" CONCRETE SHALL BE USED.
- 5) SOIL CONDITIONS SHALL BE VERIFIED BY THE S.W.S. INSPECTOR PRIOR TO CONSTRUCTION.
- 6) FOR 3" PIPE USE 4" DIAMETER THRUST RATING.

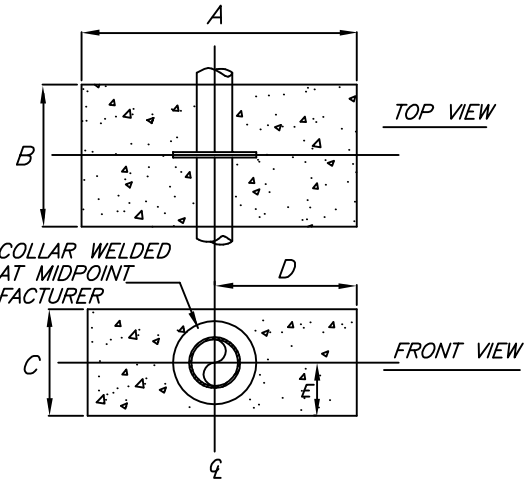

DETAIL "A" DIP ONLY

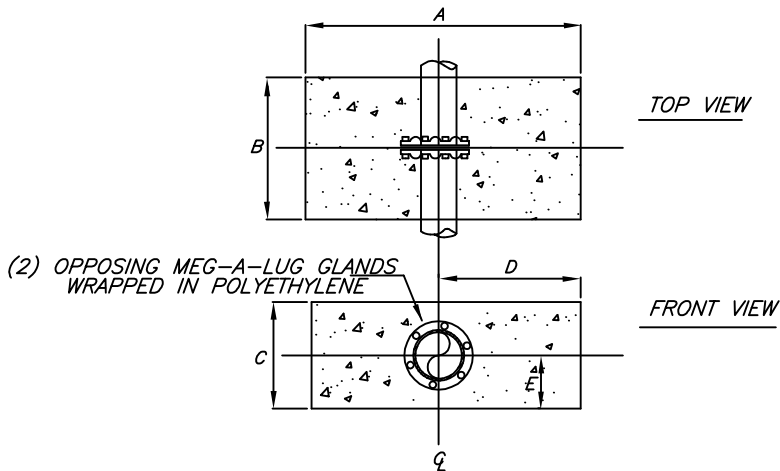

DETAIL "B" DIP ONLY

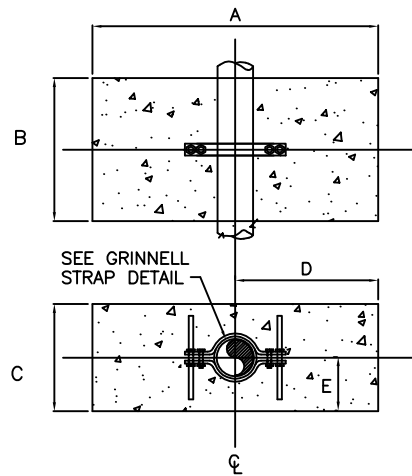

DETAIL "C" SDR-35 PVC or DIP

PIPE SIZE	A	B	C	D	E	CY.	WELDED THRUST COLLAR MINIMUM RATING
4"	3'-0"	2'-0"	1'-6"	1'-6"	0'-8"	0.33	4,500 lbs
6"	4'-0"	2'-0"	1'-6"	2'-0"	0'-9"	0.44	9,300 lbs
8"	4'-6"	2'-0"	2'-0"	2'-3"	1'-0"	0.67	16,000 lbs
12"	6'-0"	2'-0"	3'-0"	3'-0"	1'-6"	1.33	34,000 lbs
16"	6'-6"	2'-0"	4'-6"	3'-3"	2'-3"	2.17	59,000 lbs

- Detail "A" and "B" Apply to DIP in Gravity and Pressure Applications

- Detail "C" Applies to SDR-35 PVC and DIP in Gravity Applications ONLY



TYPICAL
CONCRETE COLLAR
DETAIL

SCALE: NONE

REVISION DATE: APRIL 13, 2009