

CONSTRUCTION DETAIL NO. 12

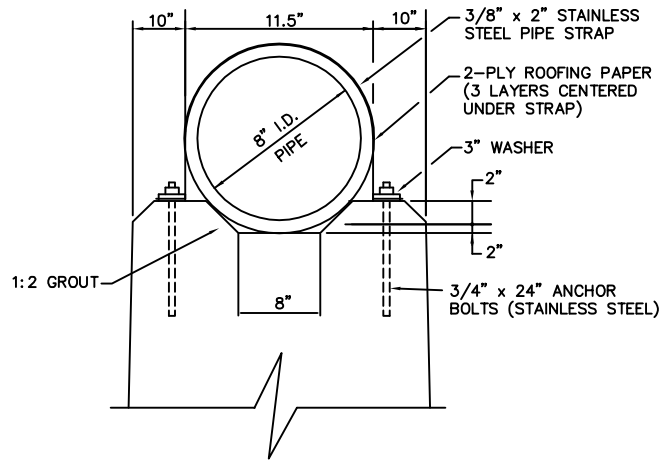

ANCHOR DETAIL
NOT TO SCALE

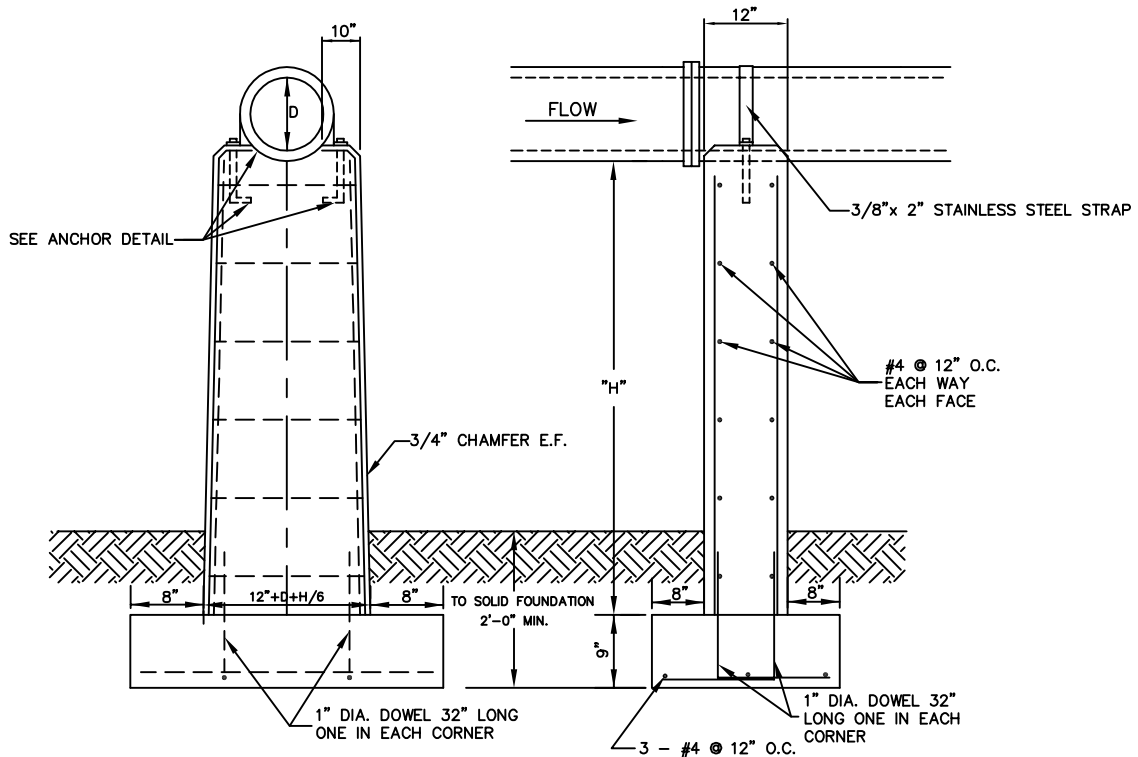

NOTE: ALL HARDWARE TO BE HOT DIPPED GALVANIZED

NOTE: THIS CONSTRUCTION DETAIL IS A SUGGESTED DESIGN ONLY AND DOES NOT RELIEVE THE DESIGN ENGINEER FROM THE RESPONSIBILITY AND OBLIGATION TO CONSIDER ALL ISSUES RELATED TO THE PROPER DESIGN OF ALL STRUCTURES AND SYSTEMS AND COMPLIANCE WITH ALL APPLICABLE REGULATIONS AND STANDARDS. THE DESIGN ENGINEER SHALL SUBMIT ALL PIER SUPPORTED PIPING SYSTEMS TO THE SPARTANBURG WATER ENGINEERING DEPARTMENT FOR APPROVAL.



PIPE SUPPORTED
ON
CONCRETE PIERS

SCALE: NONE REVISION DATE: APRIL 13, 2009